

Express Card Power Interface Switch

General Description

The RT9716A/B power distribution switches are designed to fulfill power management requirements of Express Card specification. The RT9716A/B supports systems with single slot ExpressCard|34 and ExpressCard|54 socket. The device distributes 3.3V, AUX and 1.5V to the Express Card socket. Each power rail is protected with current limit circuitry when output load exceeds over-current threshold or short-circuits occurs. A thermal protection circuit turns off switches to prevent the device from damage when power dissipation is increased by continuous heavy overloads or short-circuits in the switches. The RT9716A/B is available in WQFN-20L 4x4 package.

Ordering Information

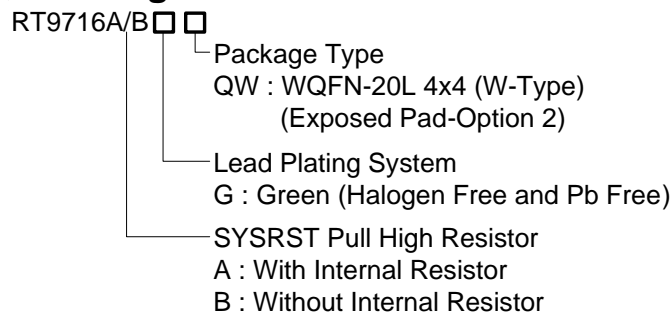

Note :

Richtek products are :

- ▶ RoHS compliant and compatible with the current requirements of IPC/JEDEC J-STD-020.
- ▶ Suitable for use in SnPb or Pb-free soldering processes.

Marking Information

For marking information, contact our sales representative directly or through a Richtek distributor located in your area.

Features

- Meets Express Card Standard (ExpressCard|34 and ExpressCard|54)
- Compliant with the Express Card Compliance Check Lists, Compliance ID : EC100288
- Fully Satisfy the Express Card Implementation Guidelines
- Supports Systems with WAKE Function
- TTL-Logic Compatible Input
- Under-Voltage Lockout Protection
- Over Current Protection
- Over Temperature Protection
- RoHS Compliant and Halogen Free

Applications

- PCs
- PDAs
- Digital Cameras
- TV and Set Top Boxes

Pin Configurations

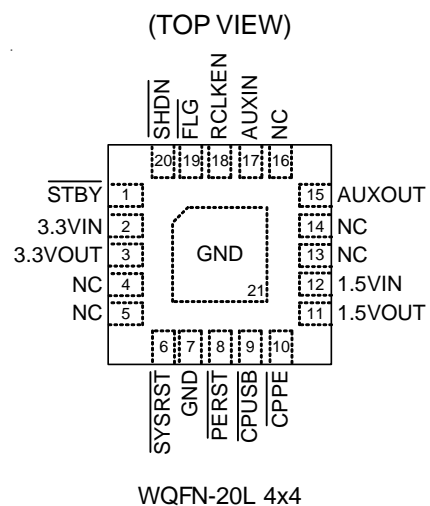

Typical Application Circuit

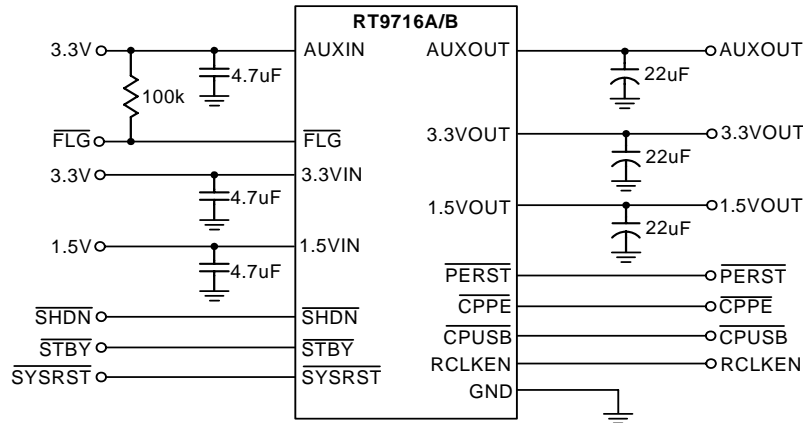

Functional Pin Description

Pin No.	Pin Name	Pin Function
1	STBY	Standby input-active low, logic level signal, Internal pulled up to AUXIN.
2	3.3VIN	Input pin for 3.3V output voltage.
3	3.3VOUT	Switched output that delivers 0V,3.3V or high impedance to card.
4, 5, 13, 14, 16	NC	No Internal Connection.
6	SYSRST	System reset input-active low, logic level signal, Internal pulled up to AUXIN for RT9716A or floating for RT9716B.
7, 21 (Exposed Pad)	GND	Ground. The exposed pad must be soldered to a large PCB and connected to GND for maximum power dissipation.
8	PERST	A logic level power good to slot (with delay).
9	CPUSB	Card present input for USB cards, Internal pulled up to AUXIN.
10	CPPE	Card present input for PCI cards, Internal pulled up to AUXIN.
11	1.5VOUT	Switched output that delivers 0V,1.5V or high impedance to card.
12	1.5VIN	Input pin for 1.5V output voltage.
15	AUXOUT	Switched output that delivers 0V,AUX or high impedance to card.
17	AUXIN	AUX input for AUXOUT and chip power.
18	RCLKEN	Reference Clock Enable signal. As an output, a logic power good to host for slot (no delay-open drain). As an input, if kept inactive(low) by the host, prevents PERST from being de-asserted. Internal pulled up to AUXIN
19	FLG	Over current or over temperature status output for slot (open drain)
20	SHDN	Shutdown input-active low, logic level signal. Internal pulled up to AUXIN

Function Block Diagram

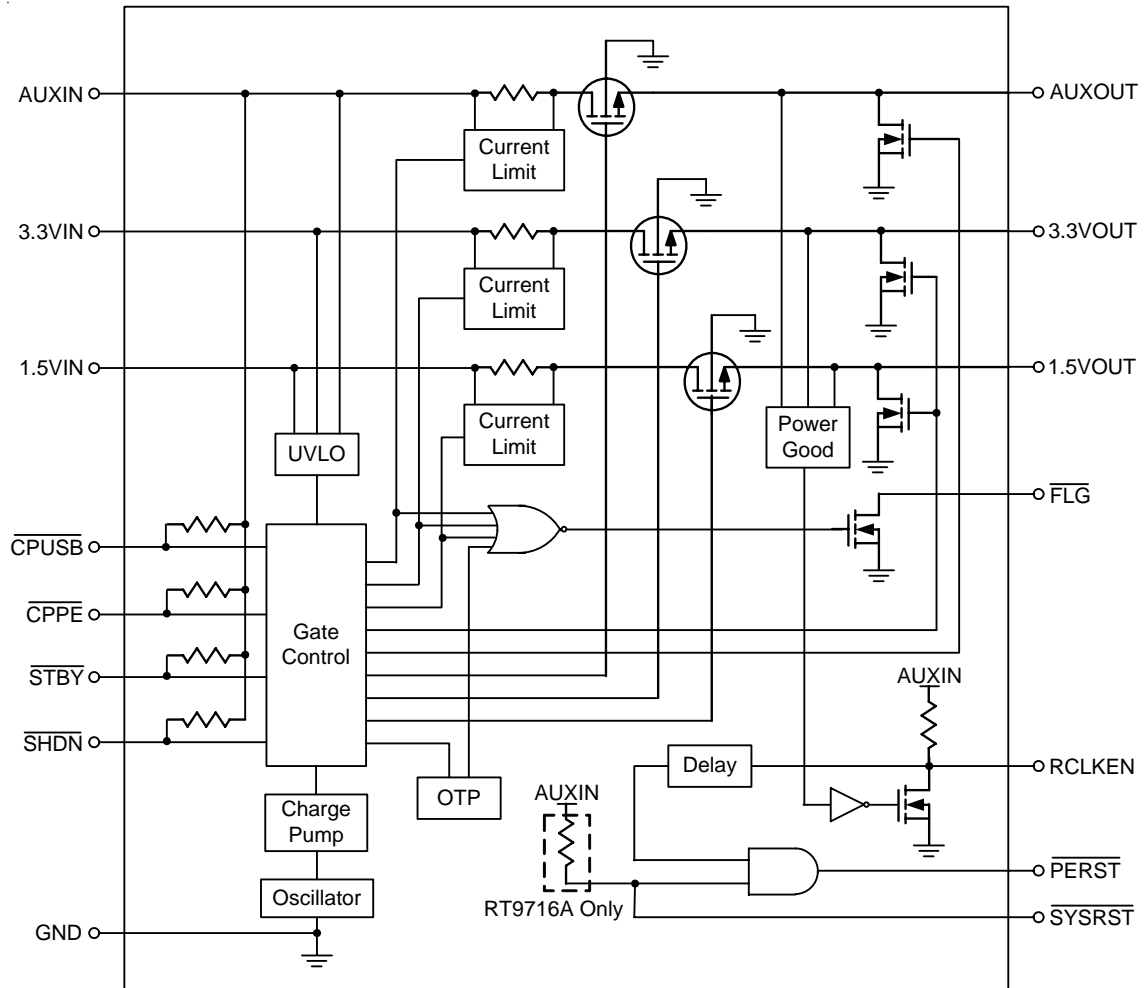

Operation

Table 1. Truth Table for Voltage Outputs

Input Power (1)			Logic Input			Output (2)			Mode (3)
AUXIN	3.3VIN	1.5VIN	SHDN	STBY	CPXX (4)	AUXOUT	3.3VOUT	1.5VOUT	
Off	X	X	X	X	X	Off	Off	Off	Off
On	X	X	0	X	X	GND	GND	GND	Shutdown
On	X	X	1	X	1	GND	GND	GND	No Card
On	Off		1	1	1 >> 0	Off	Off	Off	Off
On	ON >> Off		1	1	0	On	Off	Off	Standby (5)
On	On	On	1	0	0	On	Off	Off	Standby
On	On	On	1	1	0	On	On	On	Card Inserted

- (1) For Power Input : "On" means the respective input voltage is higher than its turn on threshold voltage; "Off" means the input voltage is lower than its UVLO falling threshold voltage. (for AUX input, "Off " means the voltage is close to 0V).
- (2) For Output : "On" means the respective power switch is turned on, so that the input is connected to the output; "Off" means the power switch and its output discharge FET are both off; "GND " means the powers switch is off but the output discharge FET is on, so that the voltage on the output is pulled down to 0V.
- (3) Mode assigns each set of input conditions and respective output voltage results to a different name. These modes are referred to as input conditions in the following " Truth Table" for Logic Outputs.
- (4) $\overline{CPXX} = 1$ when both \overline{CPUSB} and \overline{CPPE} signals are logic high, or $\overline{CPXX} = 0$ when either \overline{CPUSB} or \overline{CPPE} is low.
- (5) The card is inserted prior to the removal of the Primary or Secondary power (either 3.3VIN or 1.5VIN or both) at the input of the ExpressCard power switch, then only the Primary and Secondary power (both 3.3VOUT and 1.5VOUT) are removed and the auxiliary power is sent to the ExpressCard slot.
- (6) "X" means "Don't Care" .

Table 2. Truth Table for Logic Output

Input Conditions			Logic Outputs		
Mode	SYSRST	RCLKEN (1)	PERST	RCLKEN (2)	
OFF	X	X	0	0	
Shutdown					
No Card					
Standby	0	Hi-Z	0	1	
Card Inserted		0	0	0	0
		1	Hi-Z	1	1
		1	0	0	0

- (1) RCLKEN acts as a logic input in this column. RCLKEN is an I/O pin and it can be driven low externally, left open, or connected to high-impedance terminals, such as the gate of a MOSFET. It must not be driven high externally.
- (2) RCLKEN acts as a logic output in this column.

Absolute Maximum Ratings (Note 1)

- Supply Voltage (AUXIN, 3.3VIN) ----- -0.3V to 5V
- Supply Voltage 1.5VIN ----- -0.3V to 2.5V
- Logic Input/Output Voltage ----- -0.3V to 5V
- Power Dissipation, P_D @ T_A = 25°C
- WQFN-20L 4x4 ----- 1.389W
- Package Thermal Resistance (Note 2)
- WQFN-20L 4x4, θ_{JA} ----- 54°C/W
- WQFN-20L 4x4, θ_{JC} ----- 7°C/W
- Junction Temperature ----- 150°C
- Lead Temperature (Soldering, 10 sec.) ----- 260°C
- Storage Temperature Range ----- -65°C to 150°C
- ESD Susceptibility (Note 3)
- HBM (Human Body Mode) ----- 2kV
- MM (Machine Mode) ----- 200V

Recommended Operating Conditions (Note 4)

- Supply Voltage (AUXIN, 3.3VIN) ----- 3V to 3.6V
- Supply Voltage (1.5VIN) ----- 1.35V to 1.65V
- Junction Temperature Range ----- -40°C to 100°C
- Ambient Temperature Range ----- -40°C to 85°C

Electrical Characteristics

(V_(3.3VIN) = V_(AUXIN) = 3.3V, V_(1.5VIN) = 1.5V, V_{SHDN} = V_{STBY} = V_{SYSRST} = 3.3V, V_{CPPE} = V_{CPUSB} = 0V, $\overline{\text{PERST}}$, $\overline{\text{FLG}}$, RCLKEN are open, all output voltage are unloaded; T_A = 25°C, unless otherwise specified)

Parameter	Symbol	Test Conditions	Min	Typ	Max	Unit
Power Switch						
Switch On Resistance	R _{DS(ON)_33}	3.3VIN to 3.3VOUT, I _{OUT} = 1300mA	--	80	105	mΩ
	R _{DS(ON)_15}	1.5VIN to 1.5VOUT, I _{OUT} = 650mA	--	80	105	
	R _{DS(ON)_AUX}	AUXIN to AUXOUT, I _{OUT} = 275mA	--	140	160	
Discharge Resistance (3.3V/1.5V/AUX Output)	R _{Discharge}	V _{SHDN} = 0V, I _{Discharge} = 1mA	100	300	500	Ω
Output Short-Circuit Current (steady state value)	I _{SC_33}	Output power into a short	1350	2000	2500	mA
	I _{SC_15}		670	1000	1300	
	I _{SC_AUX}		275	450	600	
Total Input Quiescent Current (Normal Operation)	I _{Q_33}	Output are unloaded (Include $\overline{\text{CPPE}}$ and $\overline{\text{CPUSB}}$ logic pull-up current)	--	25	30	uA
	I _{Q_15}		--	25	30	
	I _{Q_AUX}		--	250	280	
Total Input Quiescent Current (Shutdown Mode)	I _{SHDN_33}	V _{CPPE} = V _{CPUSB} = V _{SHDN} = 0V, discharge FETs are on (Include $\overline{\text{CPPE}}$, $\overline{\text{CPUSB}}$ and $\overline{\text{SHDN}}$ pull-up current)	--	5	10	uA
	I _{SHDN_15}		--	5	10	
	I _{SHDN_AUX}		--	280	310	

To be continued

Parameter	Symbol	Test Conditions	Min	Typ	Max	Unit
Power Switch						
Forward Leakage Current	I_{LKF_33}	$V_{CPPE} = V_{CPUSB} = V_{SHDN} = 3.3V$, (no card present, discharge FETs are on) current measured at input pins, include RCLKEN pull-up current	--	0.1	50	uA
	I_{LKF_15}		--	0.1	50	
	I_{LKF_AUX}		--	20	50	
Reverse Leakage Current	I_{LKR_33}	$V_{3.3VOUT} = V_{AUXVOUT} = 3.3V$, $V_{1.5VOUT} = 1.5V$, all voltage inputs are grounded (current measured from output pins going in)	--	5	10	uA
	I_{LKR_15}		--	5	10	
	I_{LKR_AUX}		--	5	10	
Thermal Shutdown	T_{SD}	Rising temperature, not in over-current condition	--	130	--	°C
	T_{SD}	Rising temperature, in over-current condition	--	100	--	
	ΔT_{SD}	Hysteresis	--	20	--	
Logic Selection (SHDN, STBY, CPPE, CPUSB, SYSRST, PERST, FLG, RCLKEN)						
Logic Input Supply Current	\overline{SHDN}	$V_{SHDN} = 3.3V$, Sinking	--	0	1	uA
		$V_{SHDN} = 0V$, Sourcing	--	20	35	
	\overline{STBY}	$V_{STBY} = 3.3V$, Sinking	--	0	1	
		$V_{STBY} = 0V$, Sourcing	--	20	35	
	\overline{CPPE} or \overline{CPUSB}	V_{CPPE} or $V_{CPUSB} = 3.3V$, Sinking	--	0	1	
		V_{CPPE} or $V_{CPUSB} = 0V$, Sourcing	--	20	35	
\overline{SYSRST}	$V_{SYSRST} = 3.3V$, Sinking	--	0	1		
	$V_{SYSRST} = 0V$, Sourcing	--	20	35		
\overline{RCLKEN}	$V_{RCLKEN} = 0V$, Sourcing	--	20	35		
Logic Input Voltage	V_{IH}	High Level	2	--	--	V
	V_{IL}	Low Level	--	--	0.8	
RCLKEN Output Low Voltage		$I_{RCLKEN} = 60\mu A$	--	0.2	0.4	V
PERST Assertion Threshold of Output Voltage (PERST asserted when any of outputs falls below the threshold)	V_{PGOOD_33}	3.3VOUT Falling	2.7	2.85	3	V
	V_{PGOOD_15}	1.5VOUT Falling	1.2	1.27	1.35	
	V_{PGOOD_AUX}	AUXOUT Falling	2.7	2.85	3	
PERST Assertion Delay from Output Voltage		3.3VOUT, AUXOUT or 1.5VOUT falling	--	300	500	ns
PERST De-assertion Delay from Output Voltage		3.3VOUT, AUXOUT and 1.5VOUT rising within tolerance	4	10	20	ms
PERST Assertion Delay from SYSRST		Maximum time from \overline{SYSRST} assertion	--	--	500	ns
PERST Minimum Pulse Width		3.3VOUT, AUXOUT or 1.5VOUT falling out of tolerance or triggered by \overline{SYSRST}	100	250	--	us
\overline{PERST} Output Voltage		High Level, $I_{\overline{PERST}} = 500\mu A$	2.4	--	--	V
		Low Level, $I_{\overline{PERST}} = 500\mu A$	--	--	0.4	

To be continued

Parameter	Symbol	Test Conditions	Min	Typ	Max	Unit
FLG Output Low Voltage	$V_{\overline{FLG}}$	$I_{\overline{FLG}} = 2\text{mA}$	--	0.2	0.4	V
FLG Leakage Current	I_{LK_FLG}	$V_{\overline{FLG}} = 3.3\text{V}$	--	0	1	μA
FLG Delay Time	t_D	Falling into an over-current or over temperature condition	4	10	20	ms
UVLO						
3.3VIN UVLO	V_{UVLO_33}	Below which 3.3VIN and 1.5VIN switches are off (rising VIN)	2.6	2.75	2.9	V
1.5VIN UVLO	V_{UVLO_15}		1	1.125	1.25	
AUXIN UVLO	V_{UVLO_AUX}	Below which all switches are off (rising VIN)	2.6	2.75	2.9	
Hysteresis	ΔV_{UVLO}	Falling VIN	--	100	--	mV
Switching						
Output Rising Time	t_{RISE_33}	3.3VIN to 3.3VOUT, $C_{3.3VOUT} = 0.1\mu\text{F}$, $I_{3.3OUT} = 0\text{A}$	0.1	--	3	ms
		3.3VIN to 3.3VOUT, $C_{3.3VOUT} = 100\mu\text{F}$, $R_{LOAD_3.3} = V_{3.3VIN}/1\text{A}$	0.1	--	6	
	t_{RISE_15}	1.5VIN to 1.5VOUT, $C_{1.5VOUT} = 0.1\mu\text{F}$, $I_{1.5OUT} = 0\text{A}$	0.1	--	3	
		1.5VIN to 1.5VOUT, $C_{1.5VOUT} = 100\mu\text{F}$, $R_{LOAD_1.5} = V_{1.5VIN}/0.5\text{A}$	0.1	--	6	
	t_{RISE_AUX}	AUXIN to AUXOUT, $C_{AUXOUT} = 0.1\mu\text{F}$, $I_{AUXOUT} = 0\text{A}$	0.1	--	3	
		AUXIN to AUXOUT, $C_{AUXOUT} = 100\mu\text{F}$, $R_{LOAD_AUX} = V_{AUXIN}/0.25\text{A}$	0.1	--	6	
Output Falling Time when Card Removed (both CPPE and CPUSB de-asserted)	$t_{FALL_NC_33}$	3.3VIN to 3.3VOUT, $C_{3.3VOUT} = 0.1\mu\text{F}$, $I_{3.3OUT} = 0\text{A}$	10	--	150	μs
		3.3VIN to 3.3VOUT, $C_{3.3VOUT} = 20\mu\text{F}$, $I_{3.3OUT} = 0\text{A}$	2	--	30	ms
	$t_{FALL_NC_15}$	1.5VIN to 1.5VOUT, $C_{1.5VOUT} = 0.1\mu\text{F}$, $I_{1.5OUT} = 0\text{A}$	10	--	150	μs
		1.5VIN to 1.5VOUT, $C_{1.5VOUT} = 20\mu\text{F}$, $I_{1.5OUT} = 0\text{A}$	2	--	30	ms
	$t_{FALL_NC_AUX}$	AUXIN to AUXOUT, $C_{AUXOUT} = 0.1\mu\text{F}$, $I_{AUXOUT} = 0\text{A}$	10	--	150	μs
		AUXIN to AUXOUT, $C_{AUXOUT} = 20\mu\text{F}$, $I_{AUXOUT} = 0\text{A}$	2	--	30	ms
Output Falling Time when SHDN Asserted (Card is present)	$t_{FALL_SD_33}$	3.3VIN to 3.3VOUT, $C_{3.3VOUT} = 0.1\mu\text{F}$, $I_{3.3OUT} = 0\text{A}$	10	--	150	μs
		3.3VIN to 3.3VOUT, $C_{3.3VOUT} = 100\mu\text{F}$, $R_{LOAD_3.3} = V_{3.3VIN}/1\text{A}$	0.1	--	5	ms
	$t_{FALL_SD_15}$	1.5VIN to 1.5VOUT, $C_{1.5VOUT} = 0.1\mu\text{F}$, $I_{1.5OUT} = 0\text{A}$	10	--	150	μs
		1.5VIN to 1.5VOUT, $C_{1.5VOUT} = 100\mu\text{F}$, $R_{LOAD_1.5} = V_{1.5VIN}/0.5\text{A}$	0.1	--	5	ms
	$t_{FALL_SD_AUX}$	AUXIN to AUXOUT, $C_{AUXOUT} = 0.1\mu\text{F}$, $I_{AUXOUT} = 0\text{A}$	10	--	150	μs
		AUXIN to AUXOUT, $C_{AUXOUT} = 100\mu\text{F}$, $R_{LOAD_AUX} = V_{AUXIN}/0.25\text{A}$	0.1	--	5	ms

- Note 1.** Stresses beyond those listed under “Absolute Maximum Ratings” may cause permanent damage to the device. These are stress ratings only, and functional operation of the device at these or any other conditions beyond those indicated in the operational sections of the specifications is not implied. Exposure to absolute maximum rating conditions for extended periods may affect device reliability.
- Note 2.** θ_{JA} is measured in the natural convection at $T_A = 25^\circ\text{C}$ on a high effective four layers thermal conductivity test board of JEDEC 51-7 thermal measurement standard. The case point of θ_{JC} is on the expose pad for the WQFN package.
- Note 3.** Devices are ESD sensitive. Handling precaution is recommended.
- Note 4.** The device is not guaranteed to function outside its operating conditions.

Typical Operating Characteristics

Power On

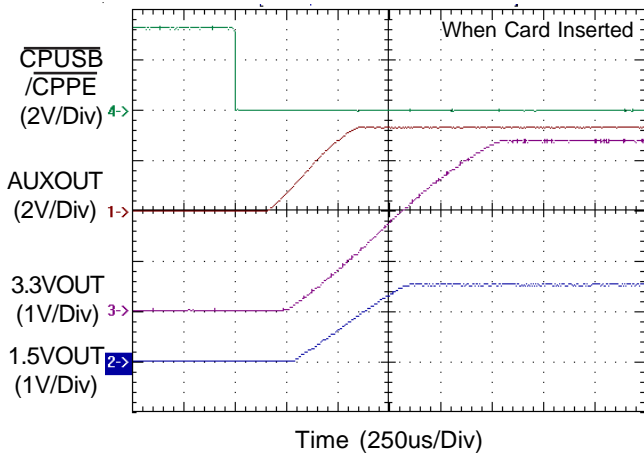

Power On

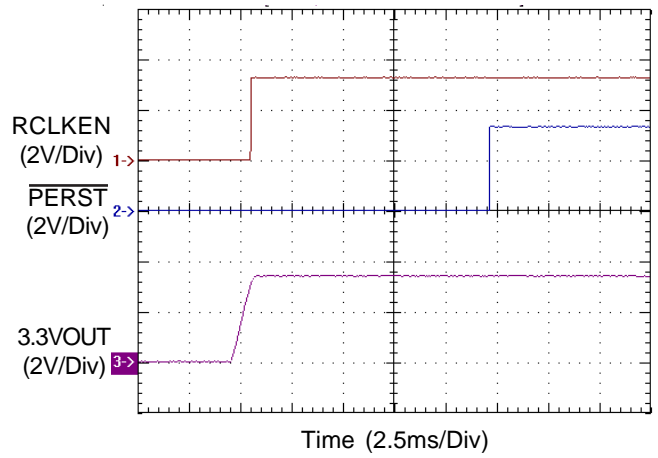

Power Off

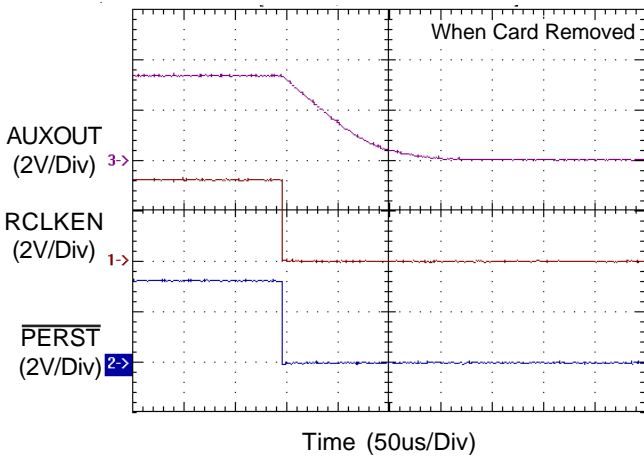

PERST Asserted by SYSRST

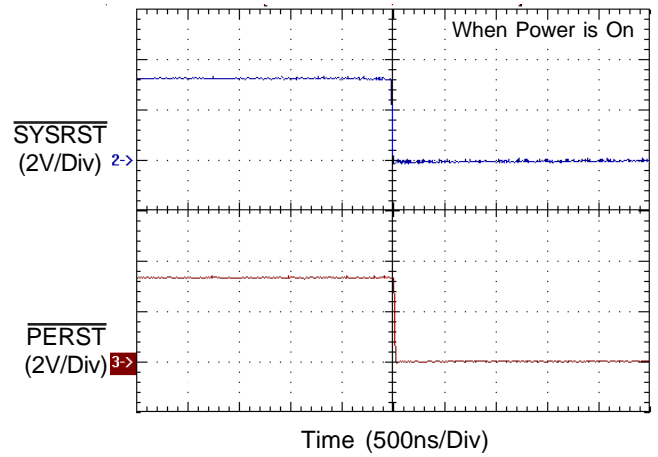

PERST DE-Asserted by SYSRST

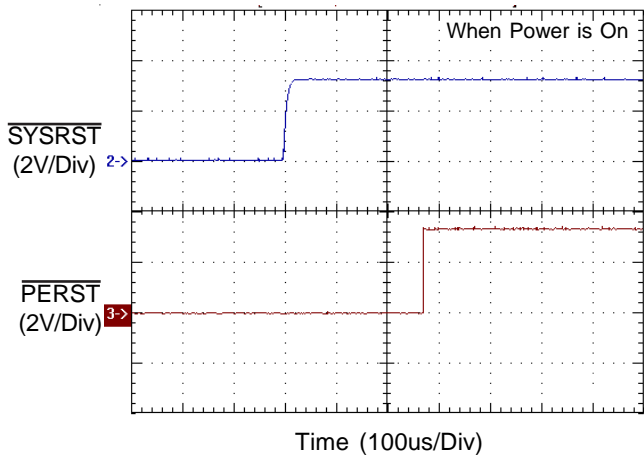

Power Off from AUXIN

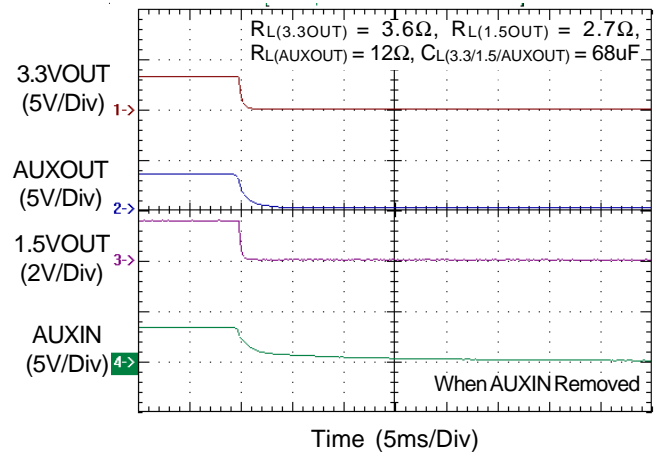

Power Off from 1.5VIN

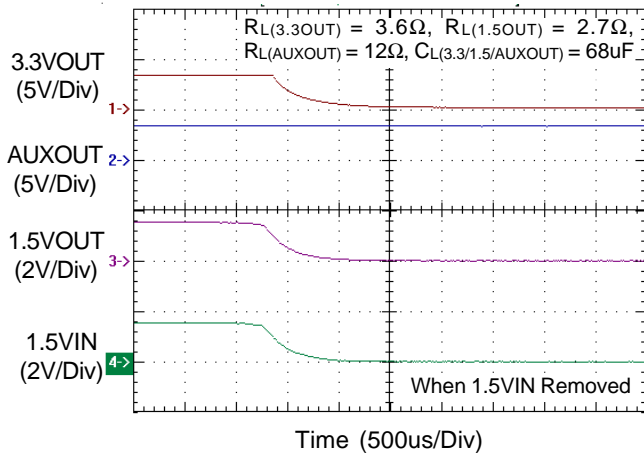

FLG Response In 3.3VOUT Short Circuit

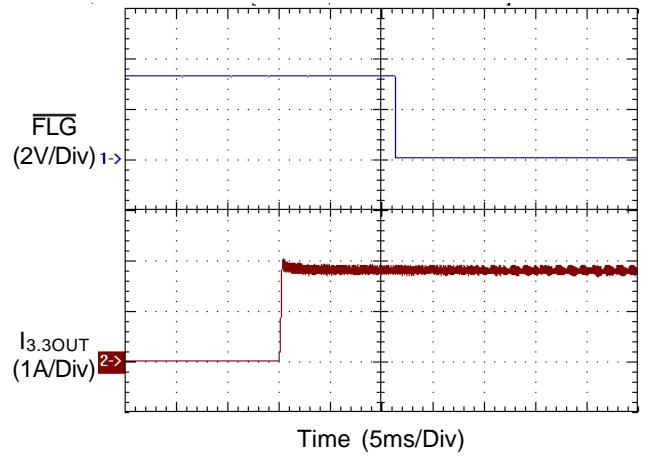

AUXIN Switch $R_{DS(ON)}$ vs. Output Current

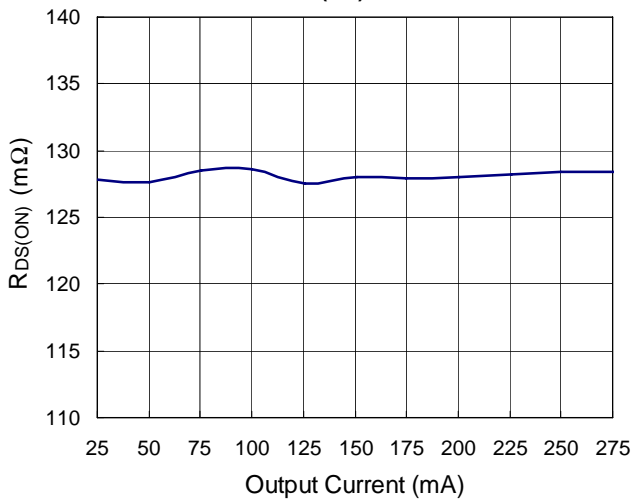

3.3V Switch $R_{DS(ON)}$ vs. Output Current

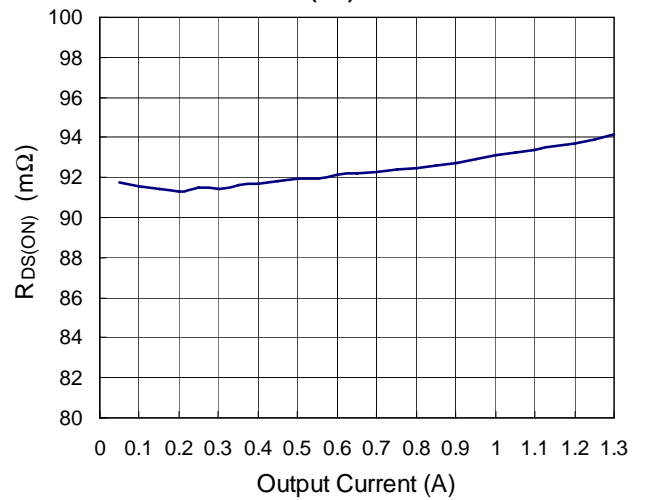

1.5V Switch $R_{DS(ON)}$ vs. Output Current

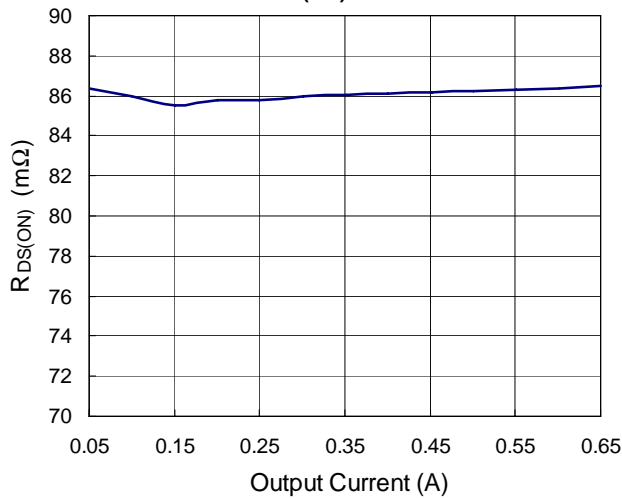

Switch $R_{DS(ON)}$ vs. Temperature

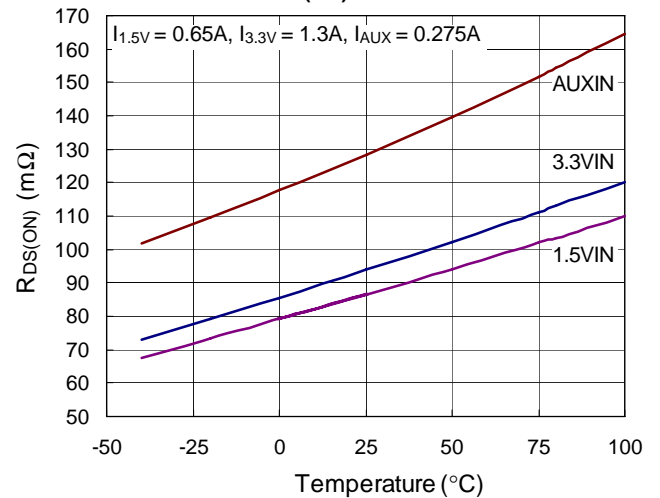

AUXIN Quiescent Current vs. Temperature

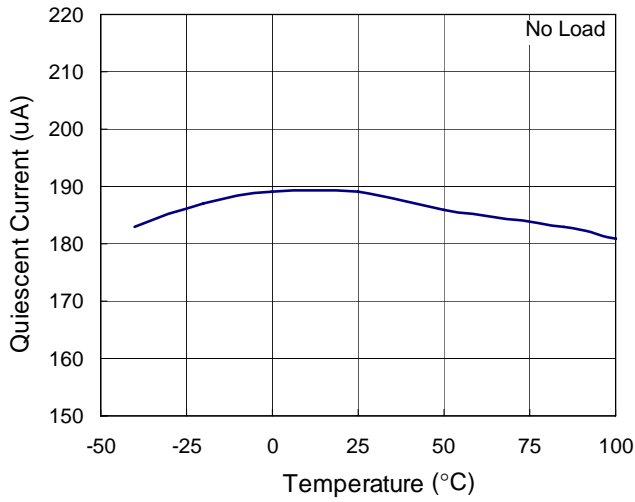

3.3VIN & 1.5VIN Quiescent Current vs. Temperature

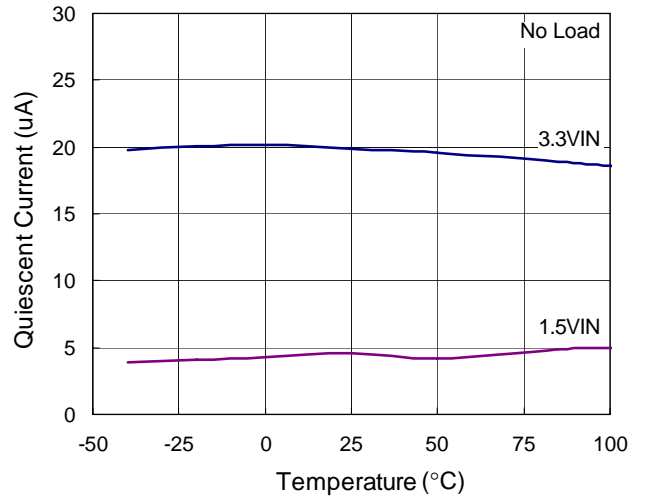

AUXIN Shutdown Current vs. Temperature

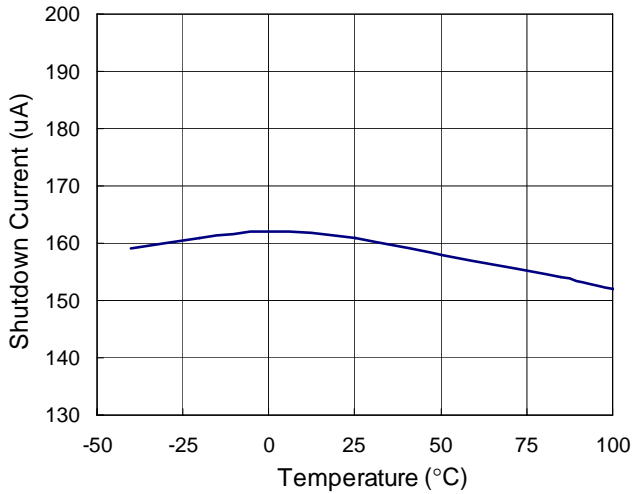

3.3VIN & 1.5VIN Shutdown Current vs. Temperature

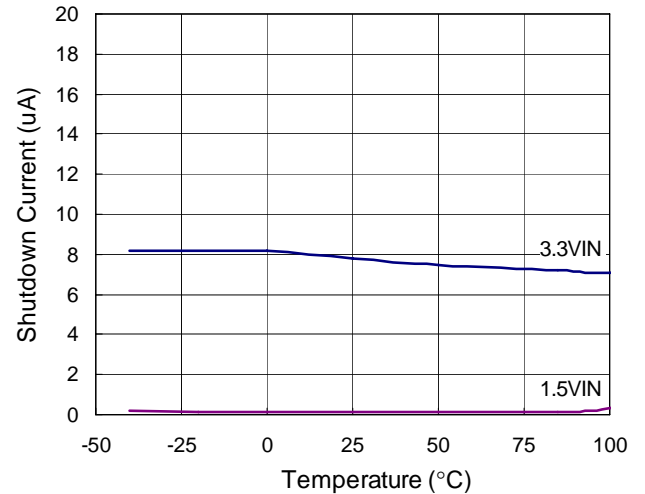

AUXOUT Current Limit vs. Temperature

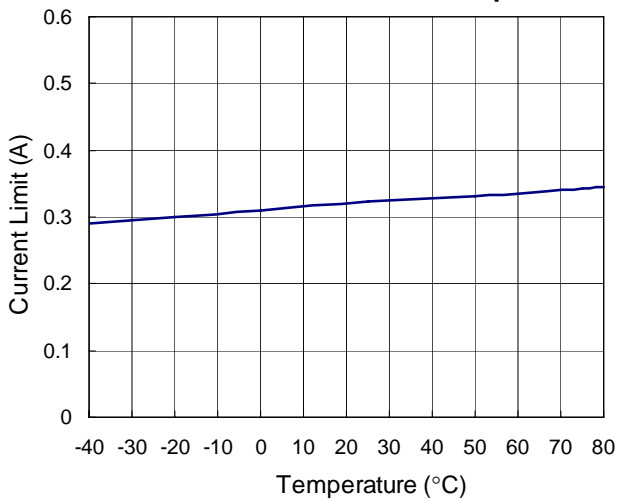

3.3VOUT Current Limit vs. Temperature

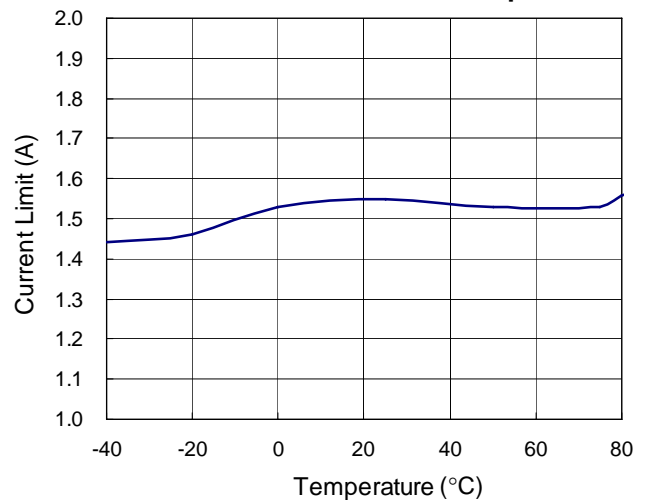

1.5VOUT Current Limit vs. Temperature

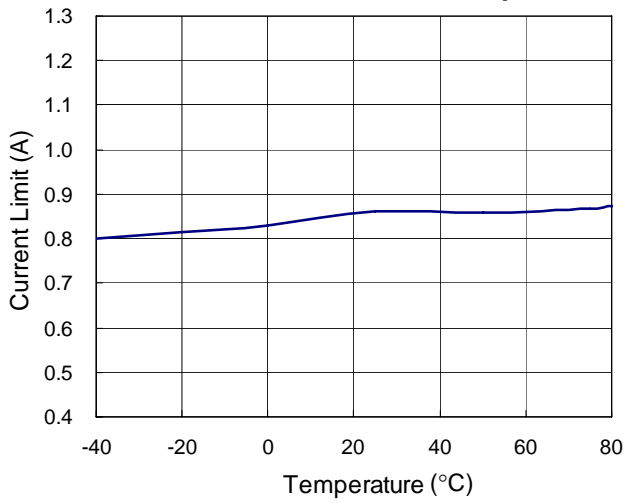

AUXIN UVLO Threshold vs. Temperature

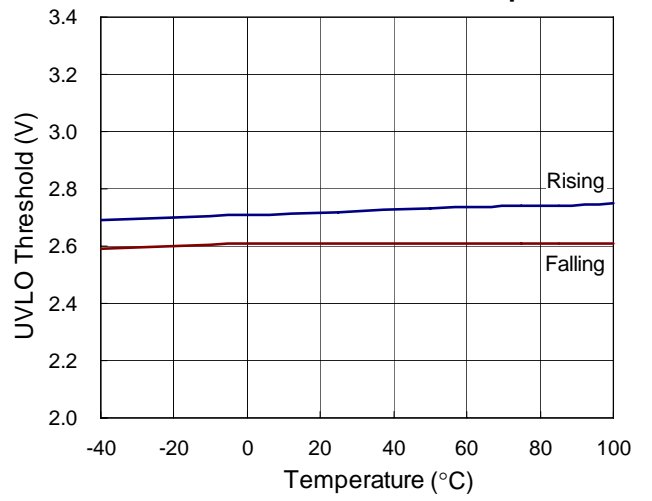

3.3VIN UVLO Threshold vs. Temperature

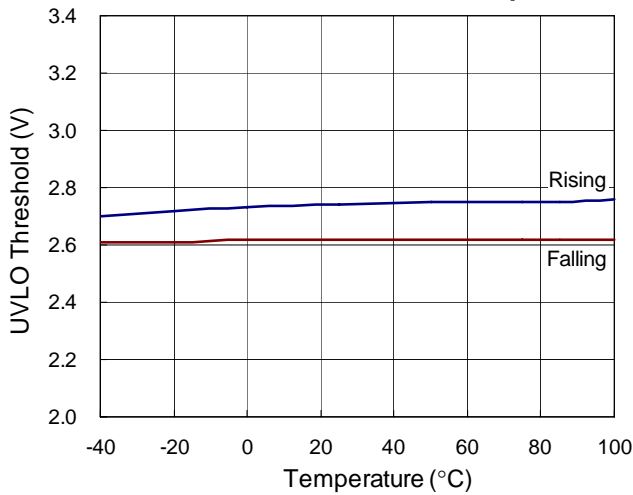

1.5VIN UVLO Threshold vs. Temperature

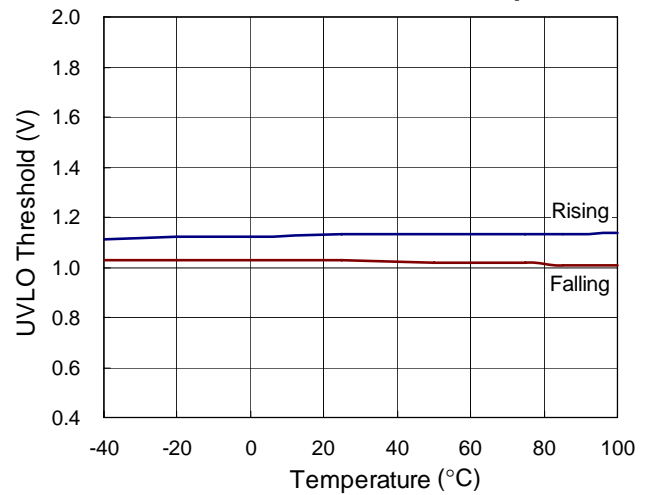

FLG Delay Time vs. Temperature

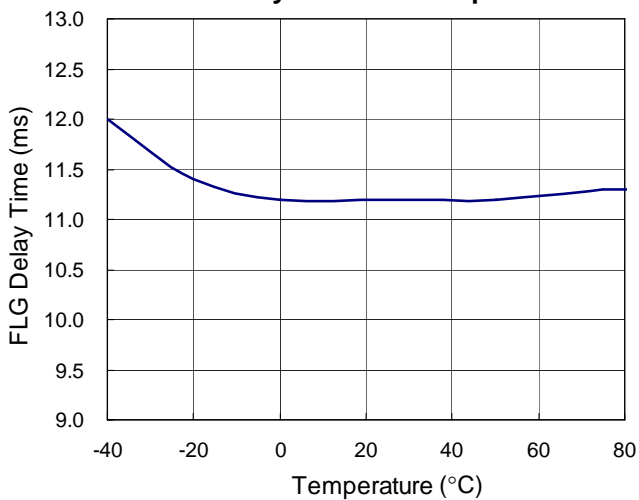

Applications Information

Power States

OFF Mode

If AUXIN is not available, and then all input-to-output power switches will be kept off.

Shutdown Mode

If AUXIN is available and $\overline{\text{SHDN}}$ is asserted (logic low), then all input-to-output power switches will be kept off and the output discharge FETs will be turned on. If $\overline{\text{SHDN}}$ is asserted and then de-asserted, the state on the output will be resumed to the state prior to $\overline{\text{SHDN}}$ assertion.

No Card Mode

If 3.3VIN, AUXIN and 1.5VIN are all available at the input of the power switch and no card is inserted, then all input-to-output power switches will be kept off and the output discharge FETs will be turned on.

Card Inserted Mode

If 3.3VIN, AUXIN and 1.5VIN are available at the input of the power switch before a card is inserted, then all input-to-output power switches will be turned on once a card-present signal ($\overline{\text{CPUSB}}$ and/or $\overline{\text{CPPE}}$) is detected.

Standby Mode

1. If a card is existed and all output voltages are being applied, then the $\overline{\text{STBY}}$ is asserted (logic low); the AUXOUT voltage is provided to the card, and the 3.3VOUT and 1.5VOUT switches will be turned off.
2. If a card is existed and all output voltages are being applied, then the 1.5VIN or 3.3VIN is removed from the input of the power switch; the AUXOUT voltage is provided to the card and the 3.3VOUT and 1.5VOUT switches will be turned off.

ExpressCard Power Switch Operation

The ExpressCard power switch resides on the host, and its main function is to control when to send power to the ExpressCard slot. The ExpressCard power switch makes decisions based on the Card Present inputs and on the state of the host system as defined by the primary and auxiliary voltage rails.

The following conditions define the operation of the host power controller :

1. When both primary power and auxiliary power at the input of the ExpressCard power switch are off, then all power to the ExpressCard connector is off regardless of whether a card is present.
2. When both primary power and auxiliary power at the input of the ExpressCard power switch are on, then power is only applied to the ExpressCard after the ExpressCard power switch detects that a card is present.
3. When primary power (either +3.3 V or +1.5 V) at the input of the ExpressCard power switch is off and auxiliary power at the input of the ExpressCard power switch is on, then the ExpressCard power switch behaves in the following manner :
 - a. If neither of the Card Present inputs is detected (no card inserted), then no power is applied to the ExpressCard slot.
 - b. If the card is inserted after the system has entered this power state, then no power is applied to the ExpressCard slot.
 - c. If the card is inserted prior to the removal of the primary power (either +3.3 V or +1.5 V or both) at the input of the ExpressCard power switch, then only the primary power (both +3.3 V and +1.5 V) is removed and the auxiliary power is sent to the ExpressCard slot.

Express Card Timing Diagrams

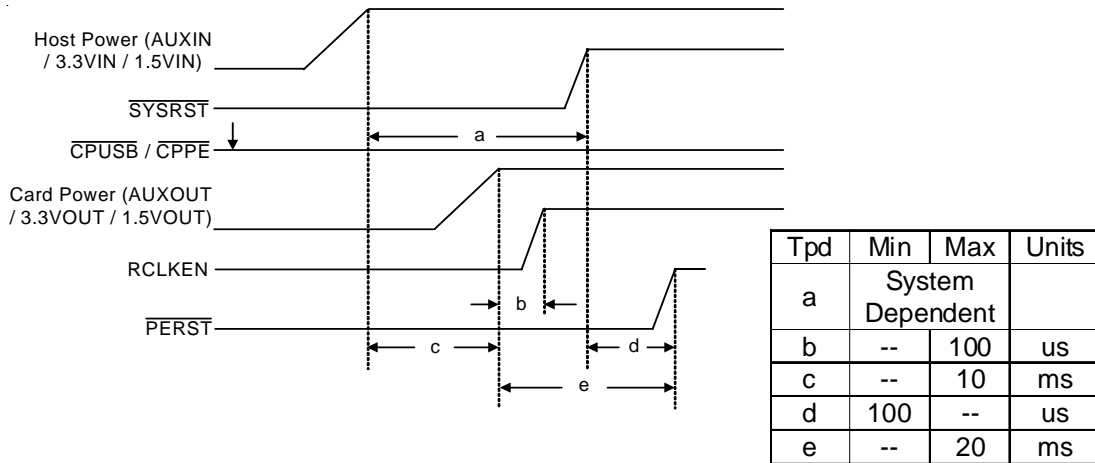

Figure 1. Card Present Before Host Power

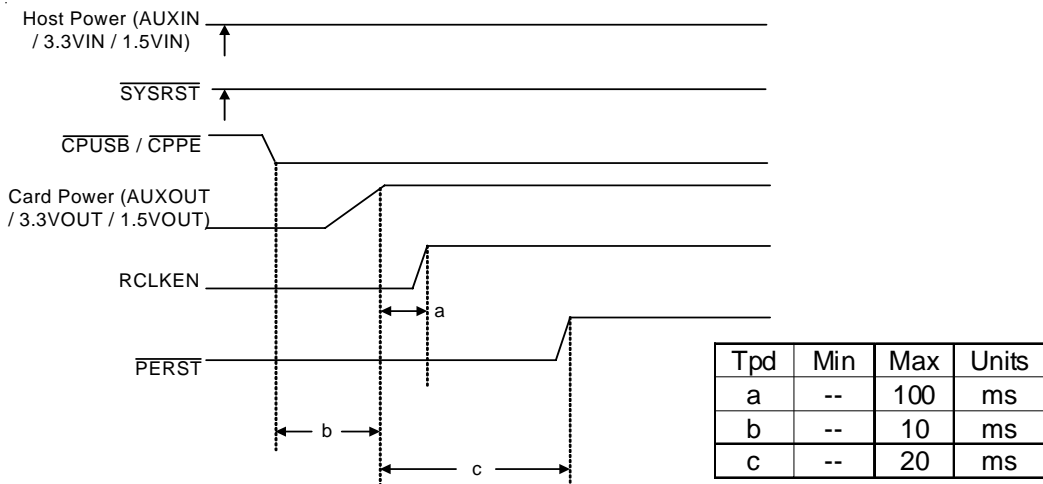

Figure 2. Host Power is On Prior to Card Insertion

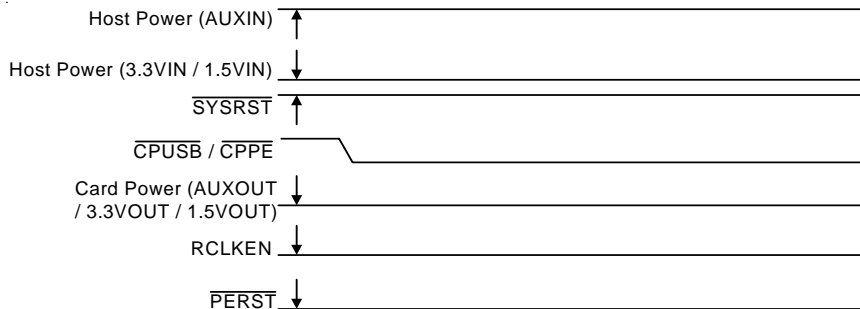

Figure 3. Host System In Standby Prior to Card Insertion

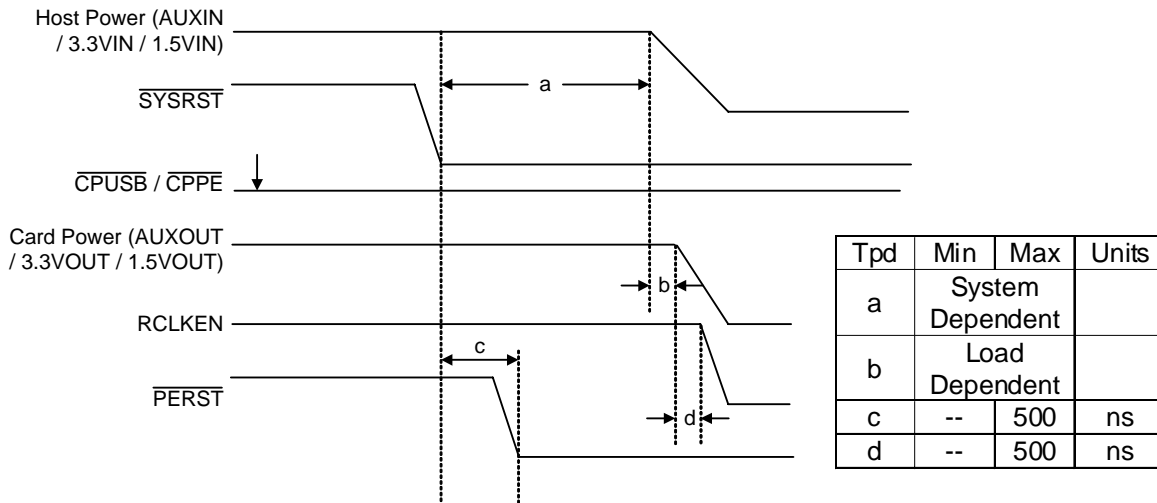

Figure 4. Host Controlled Power Down

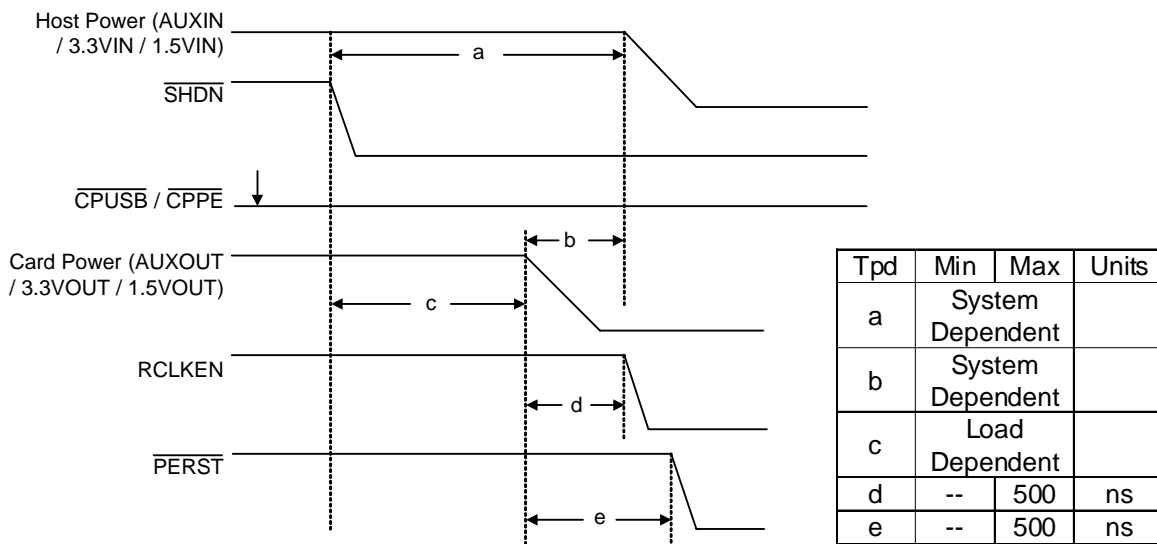

Figure 5. Controlled Power Down when $\overline{\text{SHDN}}$ Asserted

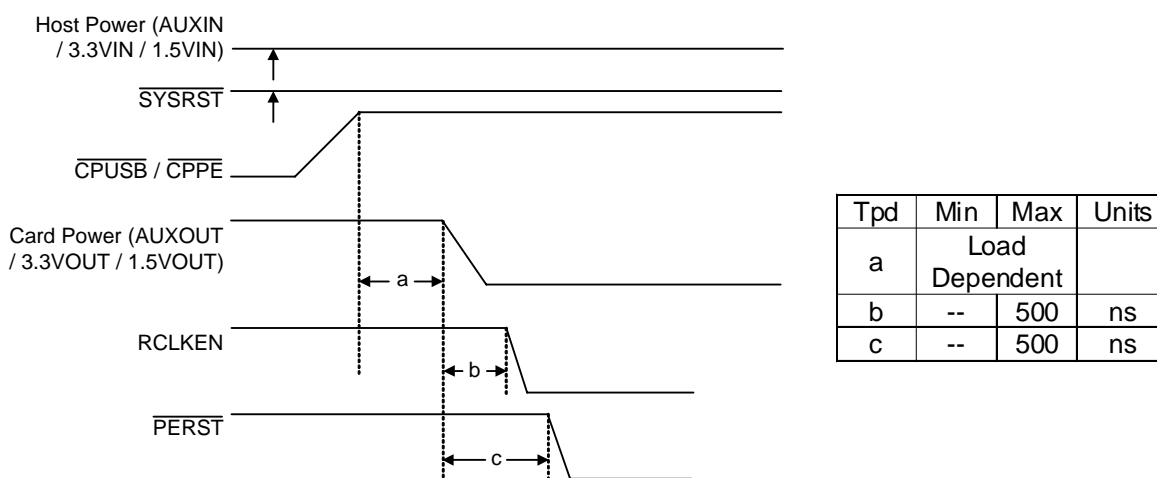

Figure 6. Surprise Card Removal

Thermal Considerations

For continuous operation, do not exceed absolute maximum operation junction temperature. The maximum power dissipation depends on the thermal resistance of IC package, PCB layout, the rate of surroundings airflow and temperature difference between junction to ambient. The maximum power dissipation can be calculated by following formula :

$$P_{D(MAX)} = (T_{J(MAX)} - T_A) / \theta_{JA}$$

Where $T_{J(MAX)}$ is the maximum operation junction temperature, T_A is the ambient temperature and the θ_{JA} is the junction to ambient thermal resistance.

For recommended operating conditions specification of RT9716A/B, the maximum junction temperature is 100°C. The junction to ambient thermal resistance θ_{JA} is layout dependent. For WQFN-20L 4x4 packages, the thermal resistance θ_{JA} is 54°C/W on the standard JEDEC 51-7 four layers thermal test board. The maximum power dissipation at $T_A = 25^\circ\text{C}$ can be calculated by following formula :

$$P_{D(MAX)} = (100^\circ\text{C} - 25^\circ\text{C}) / (54^\circ\text{C/W}) = 1.389\text{W for WQFN-20L 4x4 packages}$$

The maximum power dissipation depends on operating ambient temperature for fixed $T_{J(MAX)}$ and thermal resistance θ_{JA} . For RT9716A/B packages, the Figure 7 of derating curves allows the designer to see the effect of rising ambient temperature on the maximum power allowed.

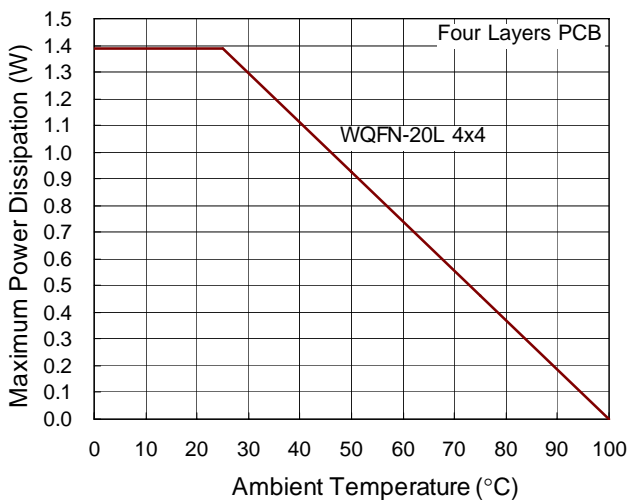
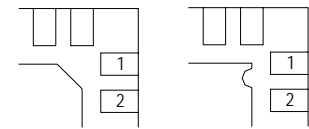
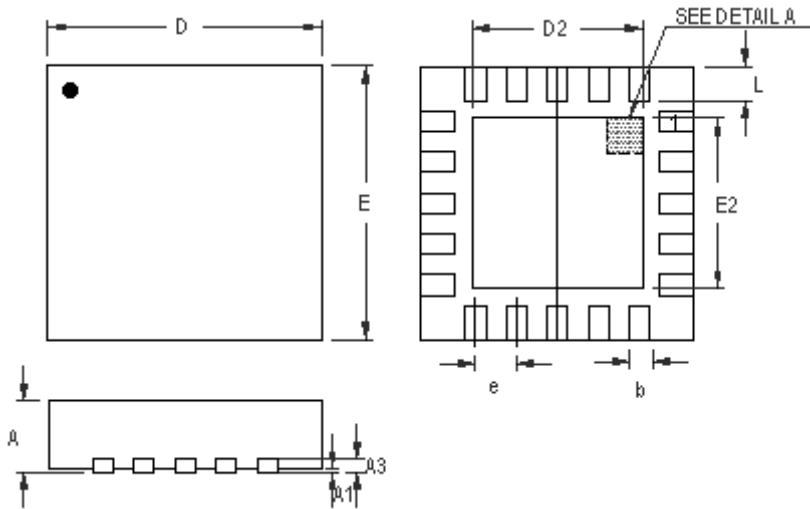

Figure 7. Derating Curves for RT9716A/B Packages

Outline Dimension



DETAIL A

Pin #1 ID and Tie Bar Mark Options

the configuration of the Pin #1 identifier is optional, but must be located within the zone indicated.

Symbol	Dimensions In Millimeters		Dimensions In Inches		
	Min	Max	Min	Max	
A	0.700	0.800	0.028	0.031	
A1	0.000	0.050	0.000	0.002	
A3	0.175	0.250	0.007	0.010	
b	0.150	0.300	0.006	0.012	
D	3.900	4.100	0.154	0.161	
D2	Option 1	2.650	2.750	0.104	0.108
	Option 2	2.100	2.200	0.083	0.087
E	3.900	4.100	0.154	0.161	
E2	Option 1	2.650	2.750	0.104	0.108
	Option 2	2.100	2.200	0.083	0.087
e	0.500		0.020		
L	0.350	0.450	0.014	0.018	

W-Type 20L QFN 4x4 Package

Richtek Technology Corporation

Headquarter
 5F, No. 20, Taiyuen Street, Chupei City
 Hsinchu, Taiwan, R.O.C.
 Tel: (8863)5526789 Fax: (8863)5526611

Richtek Technology Corporation

Taipei Office (Marketing)
 5F, No. 95, Minchiuan Road, Hsintien City
 Taipei County, Taiwan, R.O.C.
 Tel: (8862)86672399 Fax: (8862)86672377
 Email: marketing@richtek.com

Information that is provided by Richtek Technology Corporation is believed to be accurate and reliable. Richtek reserves the right to make any change in circuit design, specification or other related things if necessary without notice at any time. No third party intellectual property infringement of the applications should be guaranteed by users when integrating Richtek products into any application. No legal responsibility for any said applications is assumed by Richtek.